

Spare part list

Smart Lift®



Model/type: **SL 780 Outdoor Giant**

Smart Lift
DENMARK

N.A. Christensensvej 39, DK-7900 Nykøbing Mors

Tel.: +45 97 72 29 11 Fax: +45 97 72 39 11

E-mail: smart@smartlift.dk; www.smartlift.dk

Table of contents

1.0 - Vacuum pad and traverse	3
1.1 - Vacuum tubes and pipes	4
1.2 - Vacuum pump, valves, filter etc.....	5
2.0 - Wheels.....	6
2.1 - Drive motor, controller, side shift etc.	6
2.2 - Drive handle	7
2.3 - Steering.....	7
3.0 - Hydraulic system	8
3.1 - Hydraulic cylinder, OC-valves:	9
3.2 - Hydraulic pipes, hose etc. (right side)	10
3.3 - Hydraulic pipes, hose etc. (left side)	11
3.4 - Hydraulic pipes, hose etc. (back and inside machine)	12
4.0 - Power supply, battery and charger	13
4.0 - Power supply, battery and charger	13
5.0 - Radio and remote controller	14
5.0 - Radio and remote controller	14
6.0 - Outside covering.....	15
7.0 - Counter weight, Support legs.....	15
8.0 - Main boom	16
9.0 - Safety and signaling equipment	16
10.0 - Main fuse and electrical cabinet	17

1.0 - Vacuum pad and traverse

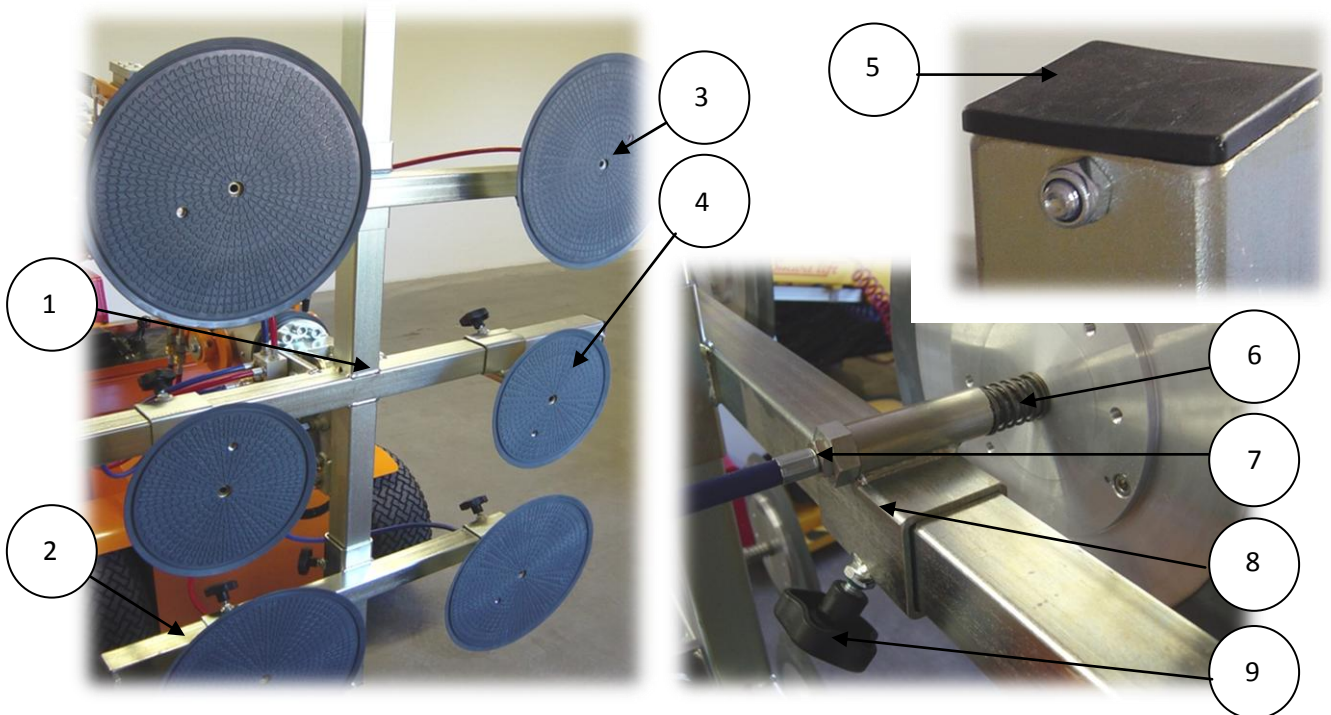

Pos	Part number	Description	Qty.
1	001036	X beam	1
2	001032	Traverse	2
3	010405	Ø 400mm Pad	4
4	010404	Ø 300mm Pad	2
5	010190	End cap 50mm	4
5	010192	End cap 60mm	4
6	010140	Spring	6
7	001045	Axl for pad, L=195mm	2
7	001035	Axl for pad, L=130mm	4
8	001046	Pad adapter 70x70	2
8	001004	Pad adapter 60x60	4
9	011039	Hand screw Ø63	8

1.1 - Vacuum tubes and pipes

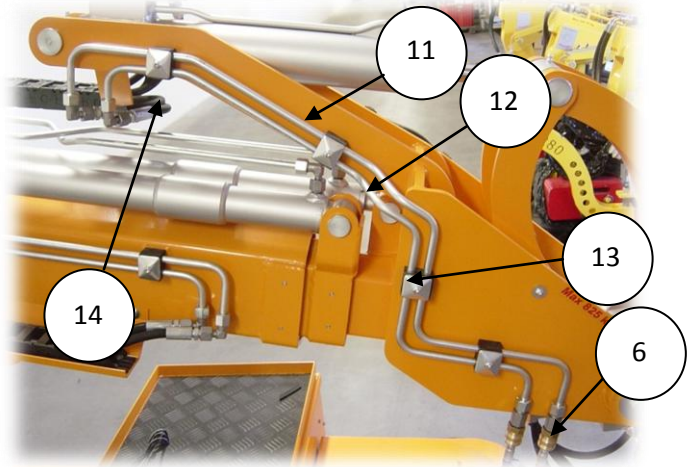
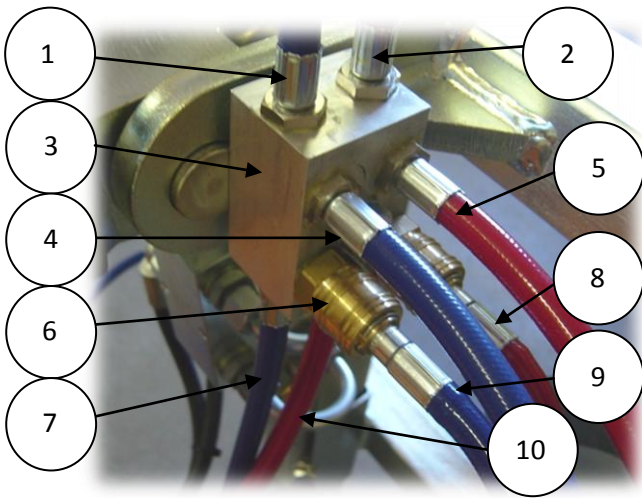

Pos	Part number	Description	Qty.
1	001050	Vacuum hose 830 mm blue	1
2	001049	Vacuum hose 930 mm red	1
3	011327	Vacuum manifold	1
4	001054	Vacuum hose 930mm blue, quick connector	1
5	001053	Vacuum hose 930mm red, quick connector	1
6	010415	Rectus quick connector 1/4"	4
7	001051	Vacuum hose 930mm blue	1
8	001052	Vacuum hose 460mm red, quick connector	1
9	001055	Vacuum hose 960mm blue, quick connector	1
10	001048	Vacuum hose 830mm red	1
11	011356	Vacuum pipe, upper part (rør 8)	1
12	011357	Vacuum pipe, under part (rør7)	1
13	011205	Pipe fixing, top	4
13a	011206	Pipe fixing, rubber part	8
14	001074	Vacuum hose 2640mm black (VR2+VB2)	2

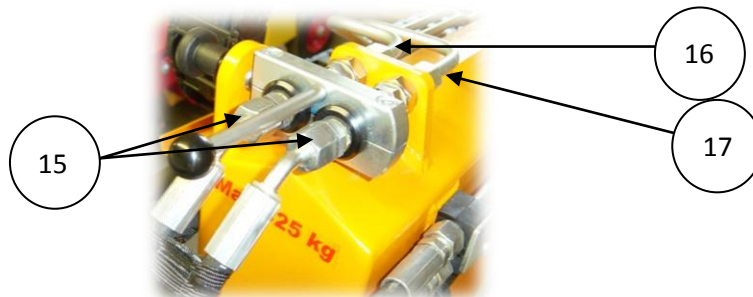

Pos	Part number	Description	Qty.
15	001073	Vacuum hose 610mm black (VR1+VB1)	2
16	011166	Vacuum pipe, Under part (rør 12)	1
17	011165	Vacuum pipe, Upper part (rør 11)	1

1.2 - Vacuum pump, valves, filter etc.

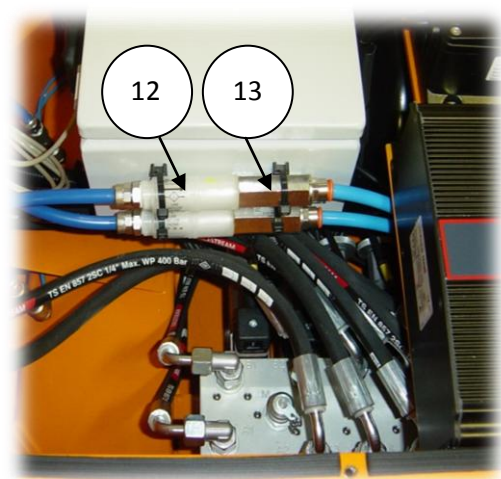
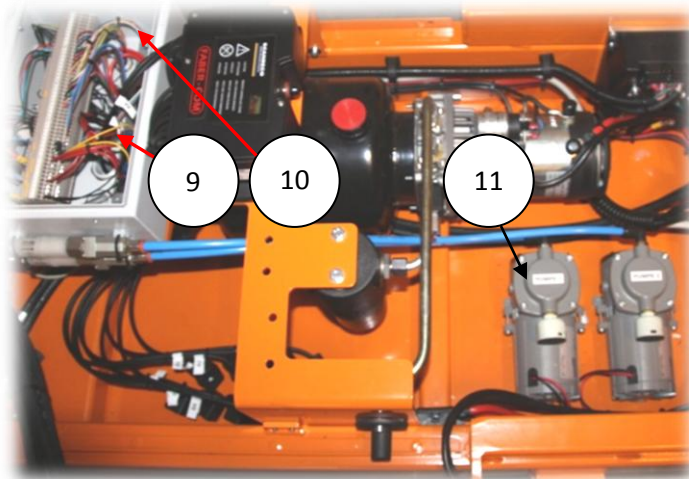
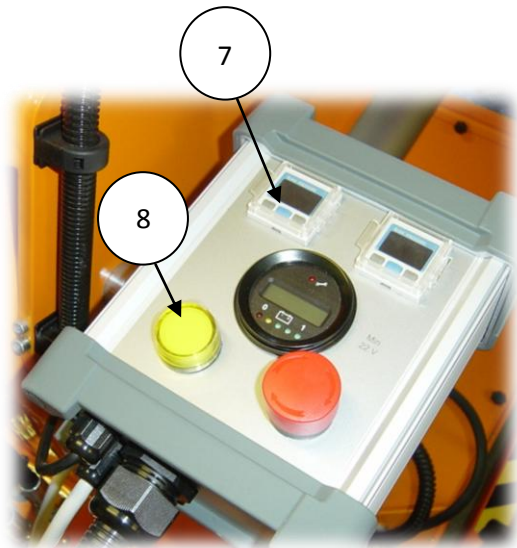
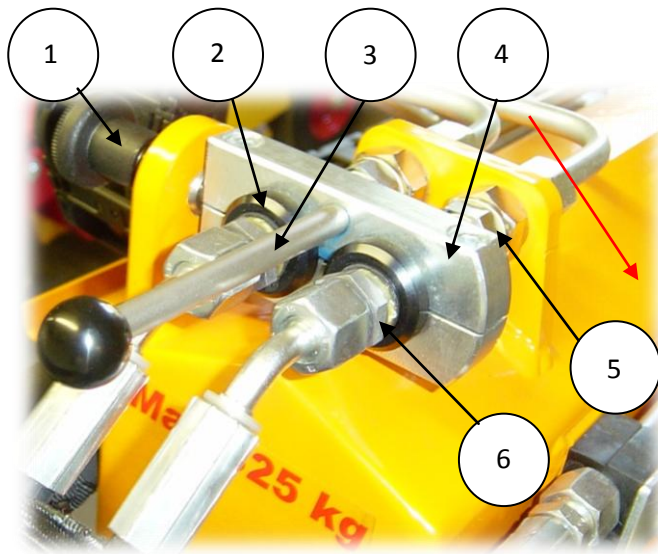

Pos	Part number	Description	Qty.
1	011036	Positioning Bolt	1
2	010222	Slide valve VCS	2
3	011037	Handle for slide valves	1
4	001015	Twin parts	1 set
5	010788	Fitting	2
6	010225	Fitting, nipple	2
7	010629	Vacuum guard	2
7a	011341	Front cower (pos 7)	2
7b	010630	Fixing set (pos 7)	2
8	010599	Lamp, yellow	1
9	010603	Relay for vacuum pump	2
10	010601	Buzzer, acoustic alarm	1
11	010087	Vacuum pump	2
12	010216	Filter	2
13	010416	Check valve	2

2.0 - Wheels



Pos	Part number	Description	Qty.
1	011200	Front wheel	2
2	010123	Wheel nut	16
3	011201	Rear wheel	2
2	010431	Wheel hub	2

2.1 - Drive motor, controller, side shift etc.

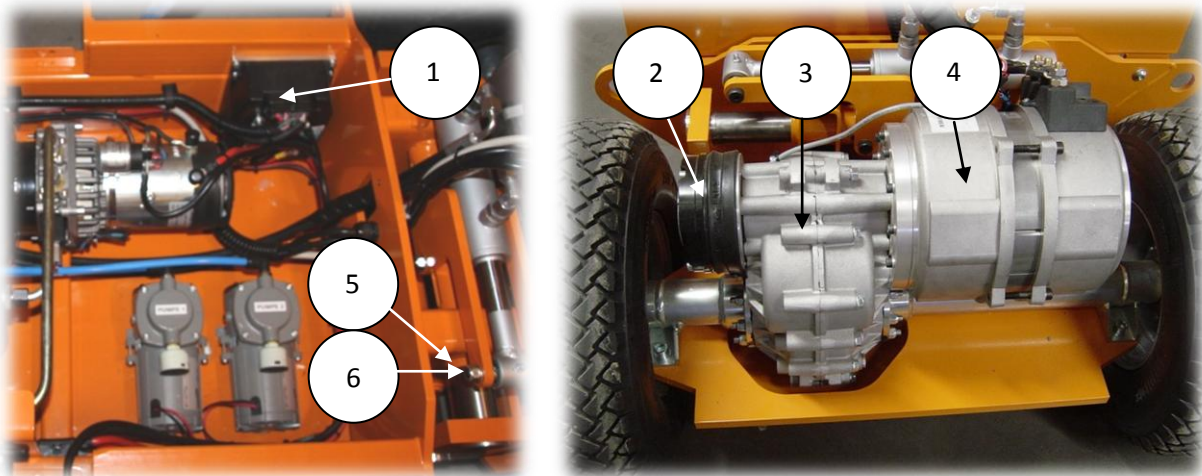

Pos	Part number	Description	Qty.
1	010078	Motor controller	1
2	011353	Brake	1
3	011354	Differential	1
4	011355	2KW motor	1
4a	010004	Drive unit TX2, complete	1
5	010391	Friction bearing 4040	4
6	010442	Center bolt M10x12x70	3

2.2 - Drive handle

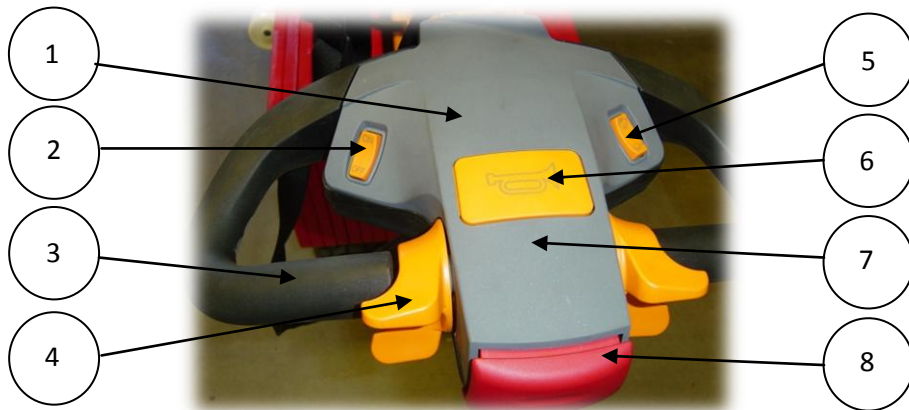

Pos	Part number	Description	Qty.
1	010090	Drive handle - Tiller head	1
1a	010586	Upper housing	1
2	010582	Switch ON-OFF	1
3	010585	Lower housing	1
4	010588	Grip with screws	1 set
5	010583	Switch H/L speed	1
6	010607	Horn botton	1
7 (Inside)	010584	Accelerator switch	1
8	010589	Belly button cover	1

2.3 - Steering

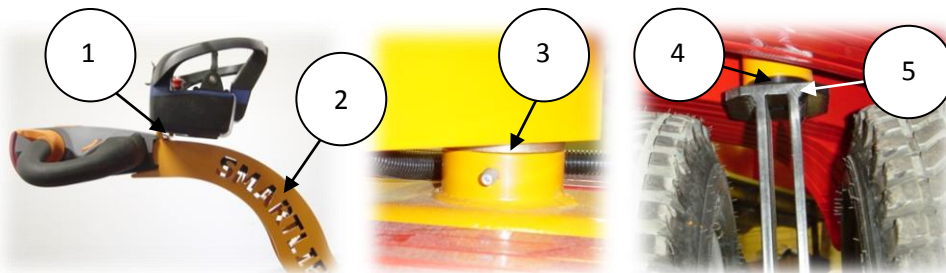

Pos	Part number	Description	Qty.
1	011291	Adapter for remote	1
2	001083	Steering arm	1
3	010387	Bronze bushings Ø40	2
4 (Inside)	011191	Thrust bearing	1
4a (Inside)	011215	Steel bushing	1
5	001084	Rear wheel suspension	1

3.0 - Hydraulic system

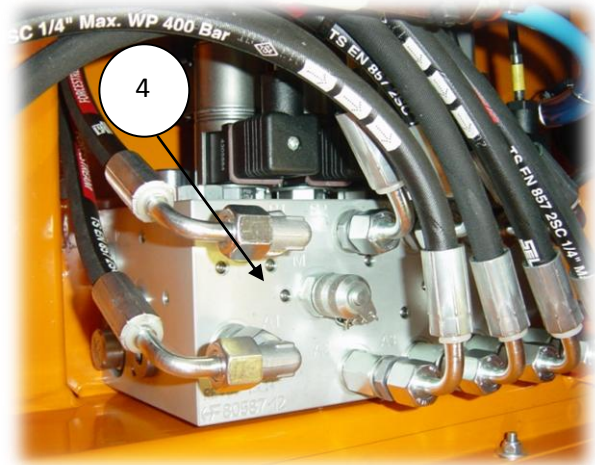
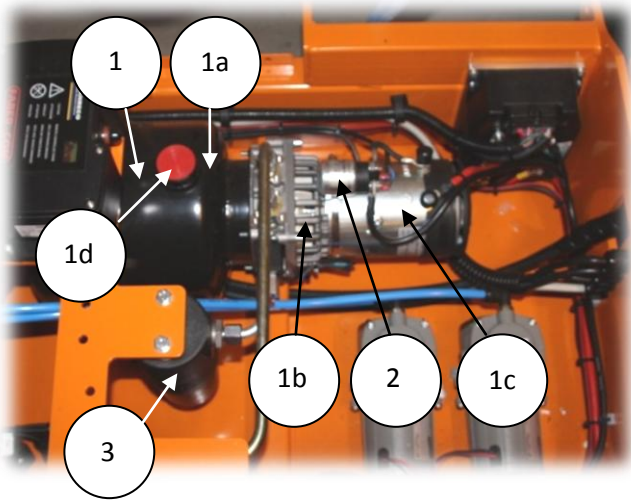

Pos	Part number	Description	Qty.
0	011155	Hydraulic oil "Rondo 32"	10 Liter
1	011117	Pump unit, complete	1
1a	011358	Tank	1
1b	011343	Pump	1
1c	011344	Motor	1
1d	011345	Oil kap	1
2	011346	Start relay	1
3	011119	Filter unit, complete	1
3a	011347	Filter	1
4	011141	Hydraulic manifold, compl.	1

Pos 4: Hydraulic manifold contains the parts below:

4a	011348	Valve, Low flow	3
4b	011349	Valve, High flow	2
4c	011350	Compensator	1
4d	011351	Coil	10
4e	011352	Pilot valve	5

3.1 - Hydraulic cylinder, OC-valves:

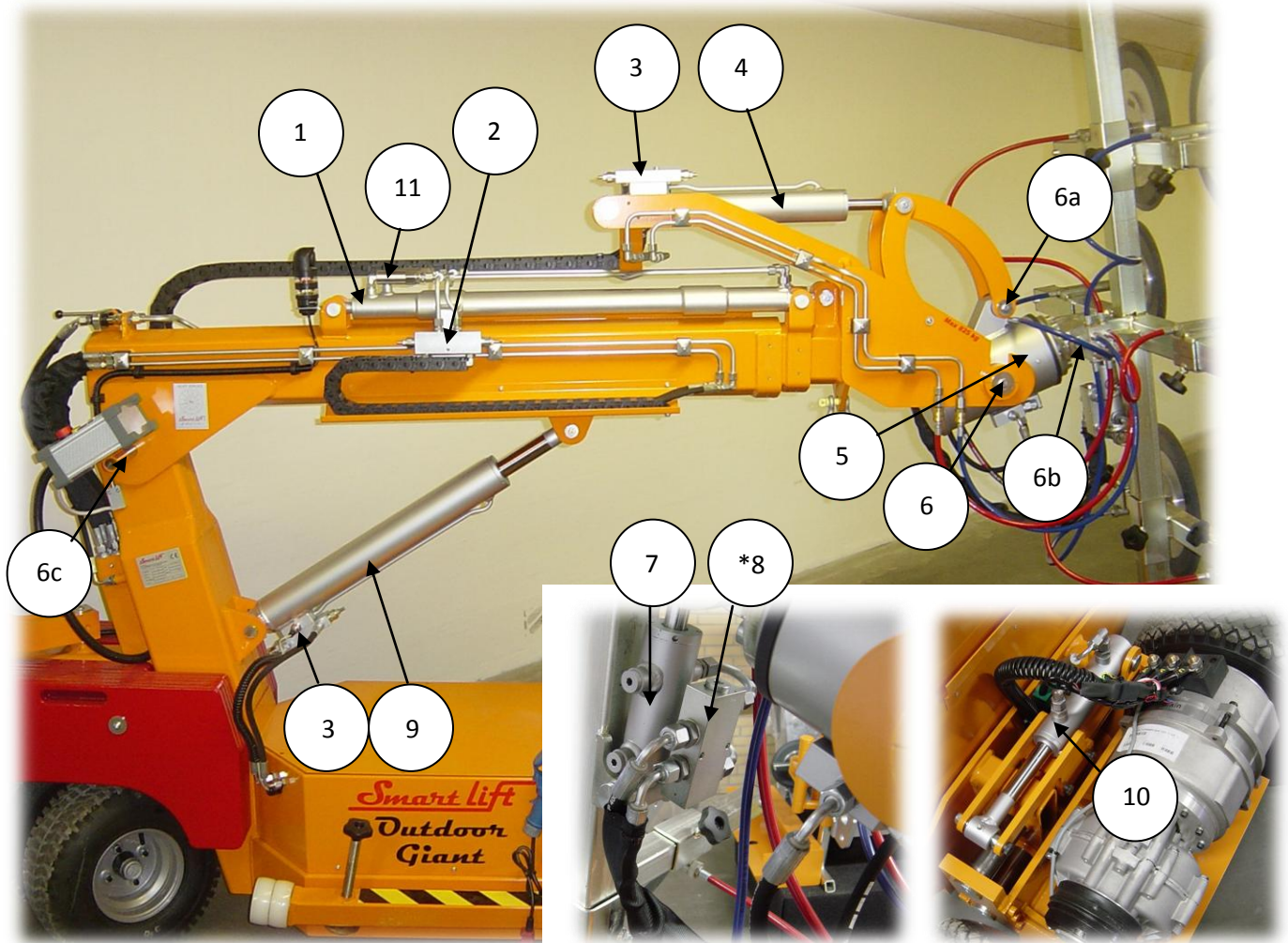

Pos	Part number	Description	Qty.
1	011151	Cylinder, telescoping	1
2	011116	OC- valve, flange model	2
3	011124	OC- valve, tube model	1
4	011152	Cylinder, tilt	1
5	011153	Actuator/OC-valve, rotation	1
6	010663	Friction bearing 3535	2
6a	010276	Friction bearing 2530	2
6b	010658	Friction bearing 3035	2
6c	010394	Friction bearing 3030	2
7	011154	Cylinder, tilt	1
*8	011124	OC- valve, tube model	1
9	011149	Cylinder, lift	1
10	011150	Cylinder, side shift	1
11	011125	Sequence valve 30 Bar	2

* The first machines build in 2013-14 was fitted with "Db pilot check valve" part no 011115. this part was changed In 2014 to 011124. We recommend the use of part no. 011124, for all machines.

3.2 - Hydraulic pipes, hose etc. (right side)

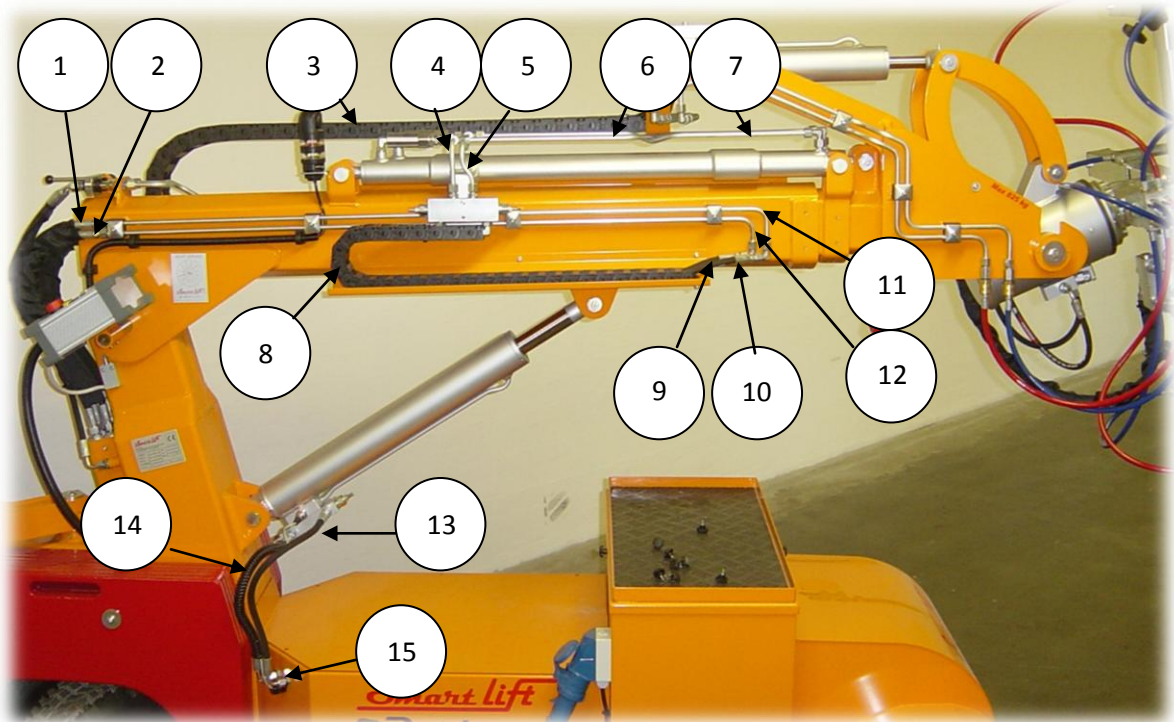

Pos	Part number	Description	Qty.
1	001065	Hose 550mm black (A3-2)	1
2	001066	Hose 500mm black (B3-2)	1
3	011192	Energy chain	50 link
3a	011193	Ends/fixing parts	1 set
4	011159	Pipe (rør 3)	1
5	011161	Pipe (rør 5)	1
6	011162	Pipe (rør 6)	1
7	011160	Pipe (rør 4)	1
8	011194	Energy chain	30 link
8a	011195	Ends/fixing parts	1 set
9	001067	Hose 980mm black (A3-3)	1
10	001068	Hose 1100mm black (B3-3)	1
11	011158	Pipe (rør 2)	1
12	011157	Pipe (rør 1)	1
13	001064	Hose 500mm black (A2-2)	1
14	001062	Hose 440mm black (B2-2)	1
15	011108	Bulkhead	12

3.3 - Hydraulic pipes, hose etc. (left side)

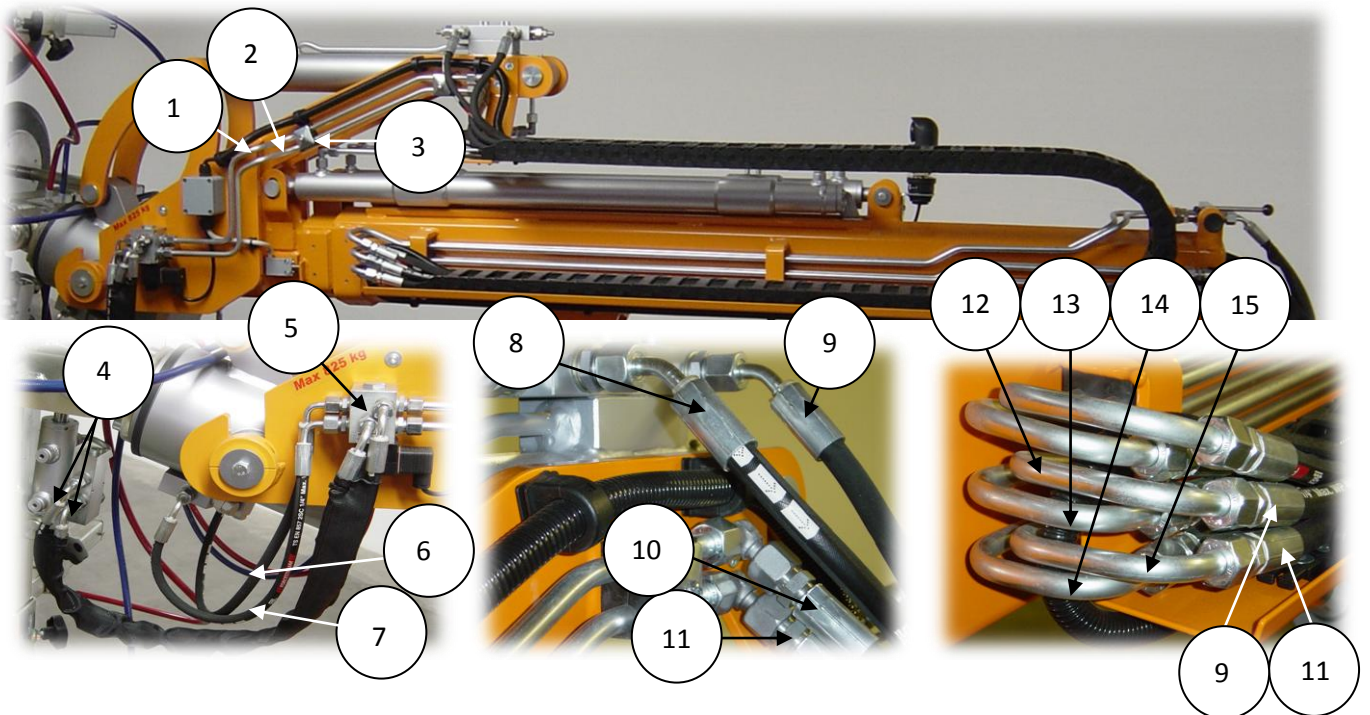

Pos	Part number	Description	Qty.
1	011163	Pipe (rør 9)	1
2	011164	Pipe (rør 10)	1
3	011205	Pipe fixing, top	3
3a	011206	Pipe fixing, rubber part	6
4	001075	Hose 900mm Black (yoke/tum)	2
5	011143	Valve 6/2	1
6	001076	Hose 500mm black (Rotation A)	1
7	001077	Hose 600mm black (Rotation B)	1
8	001070	Hose 2660mm black (B4-3)	1
9	001069	Hose 2620mm black (A4-3)	1
10	001072	Hose 2530mm black (B5-3)	1
11	001071	Hose 2550mm black (A5-3)	1
12	011168	Pipe (rør 14)	1
13	011167	Pipe (rør 13)	1
14	011169	Pipe (rør 15)	1
15	011181	Pipe (rør 16)	1

3.4 - Hydraulic pipes, hose etc. (back and inside machine)

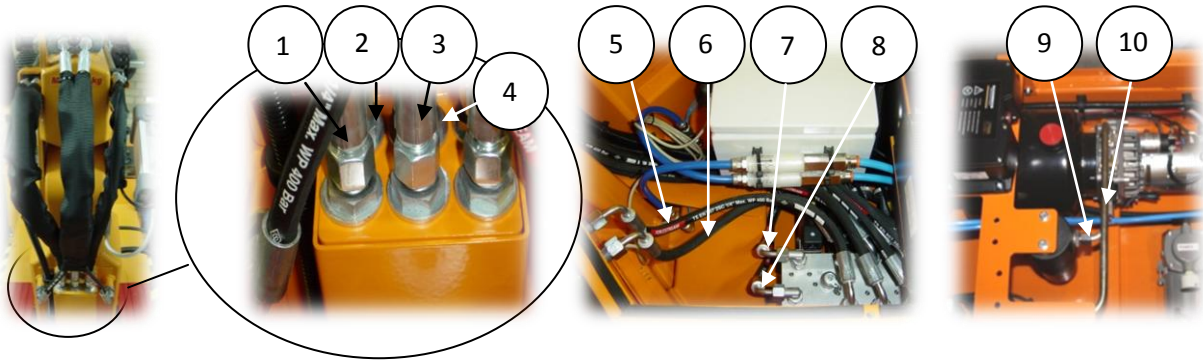

Pos	Part number	Description	Qty.
1	001066	Hose 500mm black (A5-2)	1
2	001065	Hose 550mm black (B5-2)	1
3	001065	Hose 550mm black (B4-2)	1
4	001066	Hose 500mm black (A4-2)	1
5	001058	Hose 400mm Black (A2-1)	1
6	001059	Hose 350mm black (B2-1)	1
7	001056	Hose 1400mm black (A1-1)	1
8	001057	Hose 1350mm black (B1-1)	1
9	011182	Pipe (rør 17)	1
10	011186	Pipe (rør 19)	1
*11	011183	Pipe (rør 18)	1
*12	001060	Hose 1150mm black (A3-1, A4-1, B4-1)	3
*13	001061	Hose 1050mm black (B3-1)	1
*14	001063	Hose 1200mm black (A5-1, B5-1)	2

*Part does not shown at the photos.

4.0 - Power supply, battery and charger

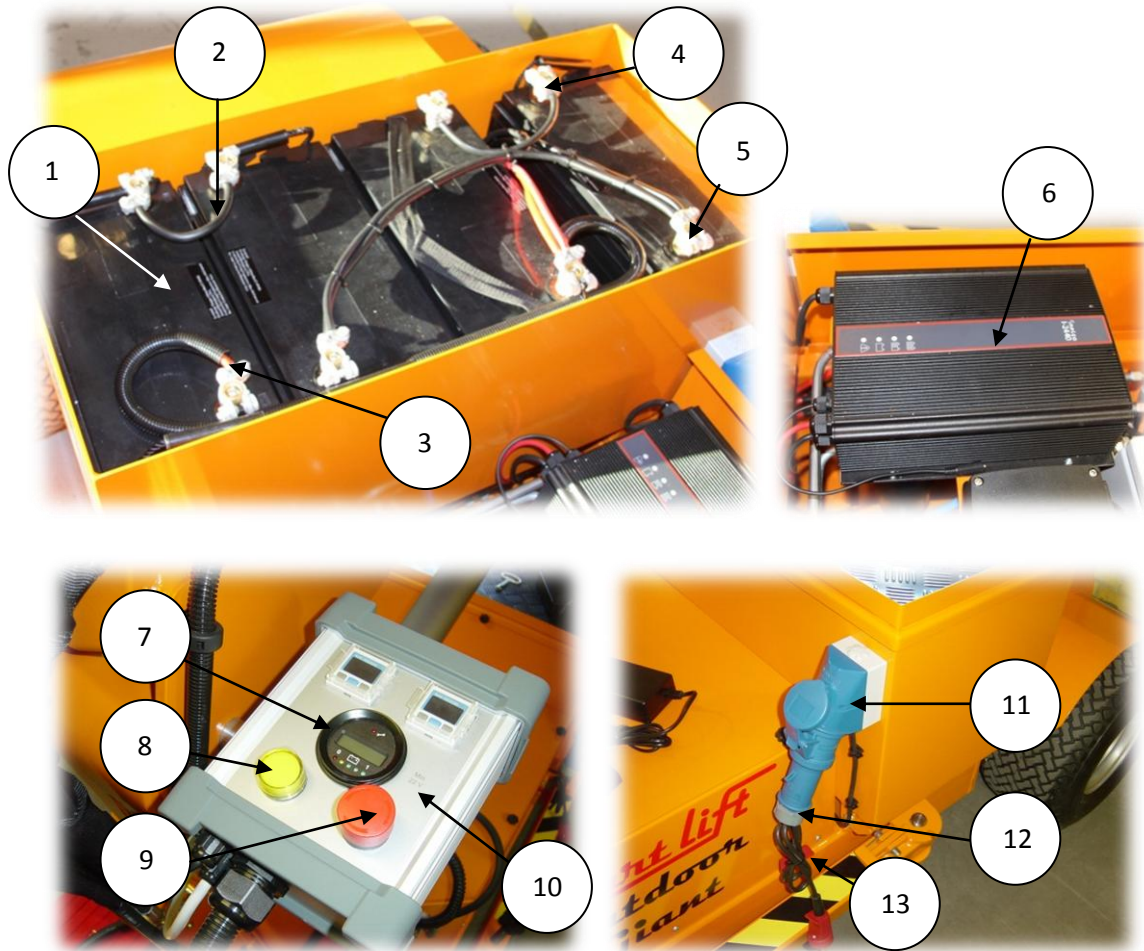

Pos	Part number	Description	Qty.
1	011170	Battery 12V -134Ah	4
2	010432	Cable 16mm ² black	X m
3	010433	Cable 16mm ² red	X m
4	010432	Pole shoe, positive	4
5	010433	Pole shoe, negative	4
6	011207	Battery charger	1
7	010077	Battery indicator	1
8	010599	Lamp, yellow	1
9	010592	Emergency switch	1
10	001047	Cabinet	1
11	010204	Power connecting	1
12	011023	Power cable EC	1
13	010259	Main switch	1
13a	010260	Key for main switch	1

5.0 - Radio and remote controller

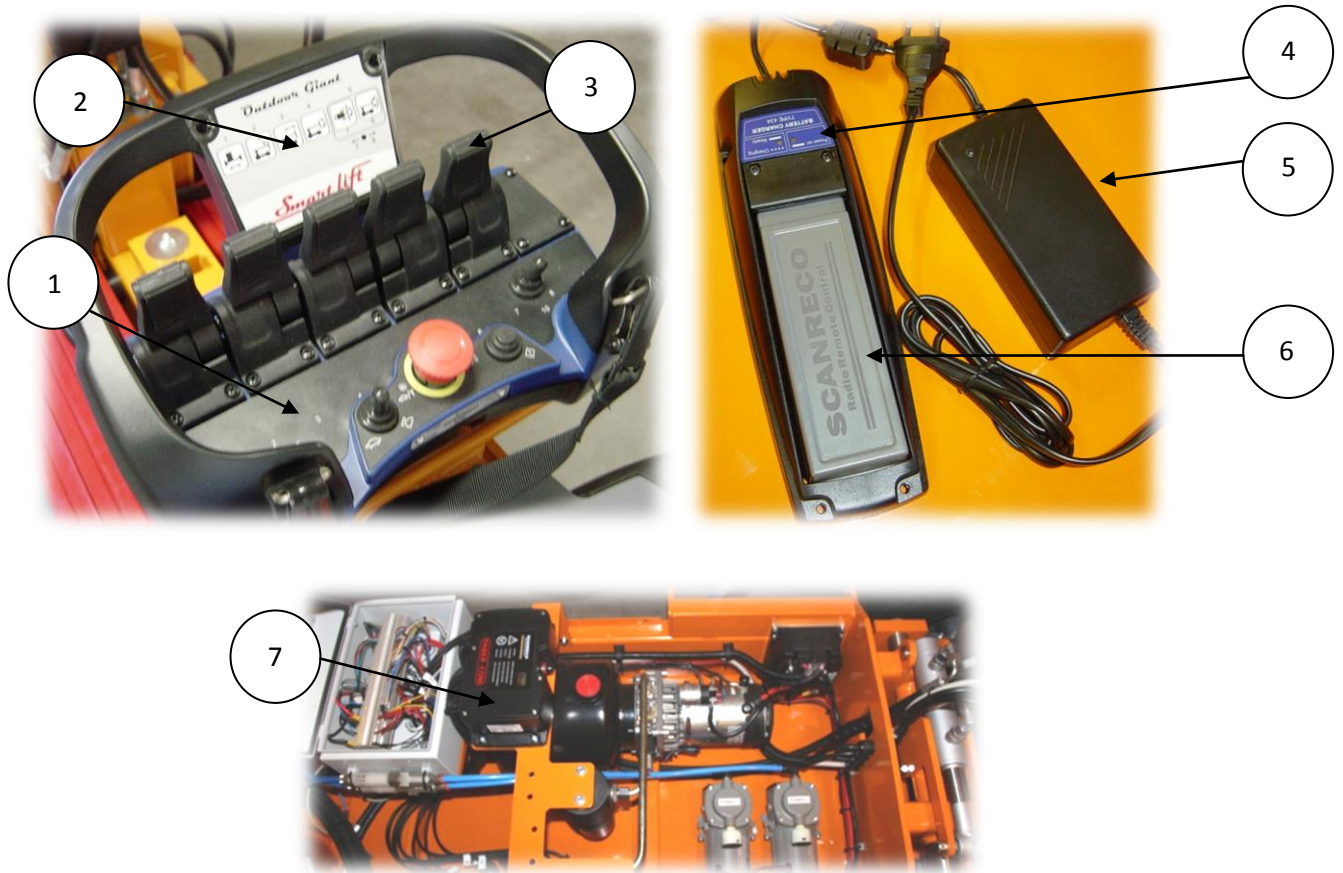

Pos	Part number	Description	Qty.
0	011145	Remote control, complete	1
1	011359	Remote handle	1
2	011360	Label for remote	1
3	010148	G2B Leaver	6
4	011361	Battery charger 10-30V DC	1
5	011368	Battery charger 110-230VAC - Not standard	
6	011198	Power unit 230V AC	1
7	010572	Battery	2
8	011362	Radio receiver	1

6.0 - Outside covering



Pos	Part number	Description	Qty.
1	001136	Top cover	1
2	001137	Right side cover	1
3	001138	Left side cover	1
4	001093	Top battery box	1
4a	011102	Rubber mat 345x735mm	1
5	011035	Finger screw	10
6	001139	Battery box	1
7	001140	Front cover	1

7.0 - Counter weight, Support legs

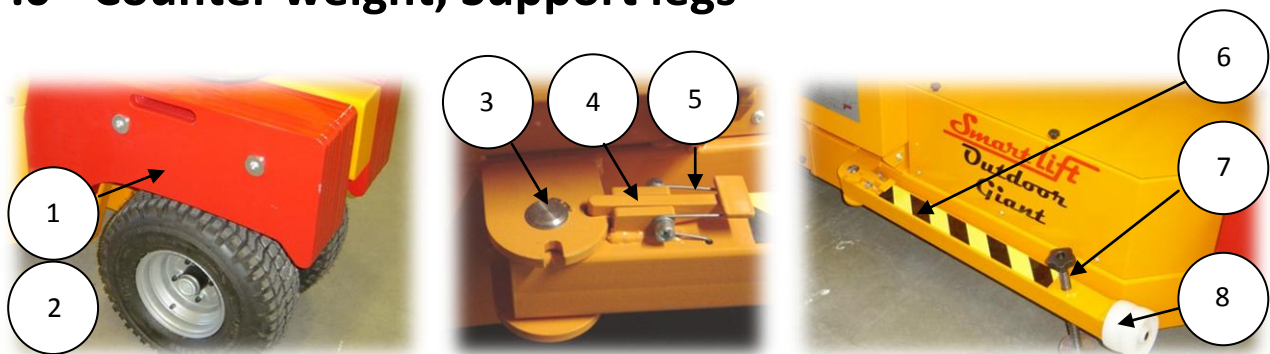

Pos	Part number	Description	Qty.
1	001042	Counter weight 28 kg	10
2	001041	Counter weight 18 kg	6
3	011029	Shaft + lock rings	2 set
4	001130	Lock	2
5	010141	Spring for lock	2 set
6	001094	Support leg	2
7	001039	Adjustment screw	2
8	010429	Support wheel	4

8.0 - Main boom

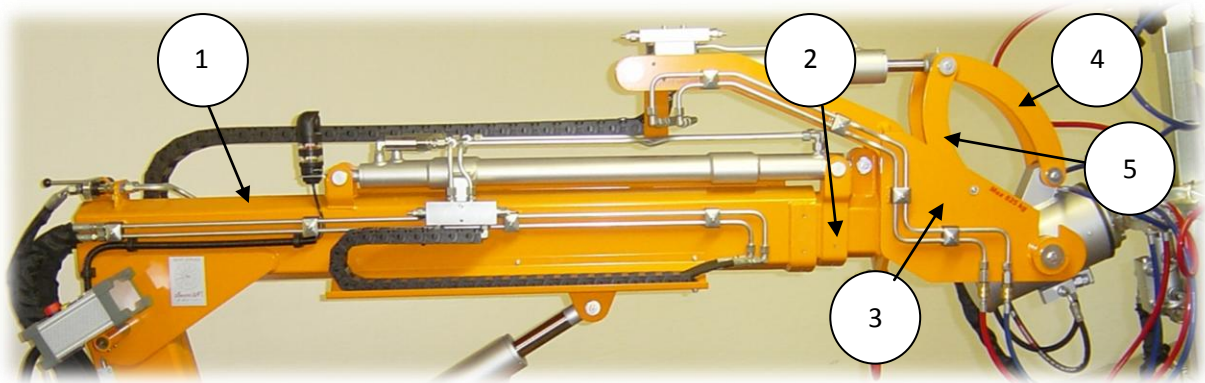

Pos.	Part number	Description	Qty.
1	001086	Main boom	1
1a (Inside)	001087*	PA Non friction set	1 set
2	001088	Medium boom	1
2a (Inside)	001089*	PA Non friction set	1 set
3	001090	Inner boom	1
4	001091	Tilt arm, long	2
5	001092	Tilt arm, short	2

*OBS! Please measure the thickness before ordering, because some of the parts can be made in oversize.

9.0 - Safety and signaling equipment

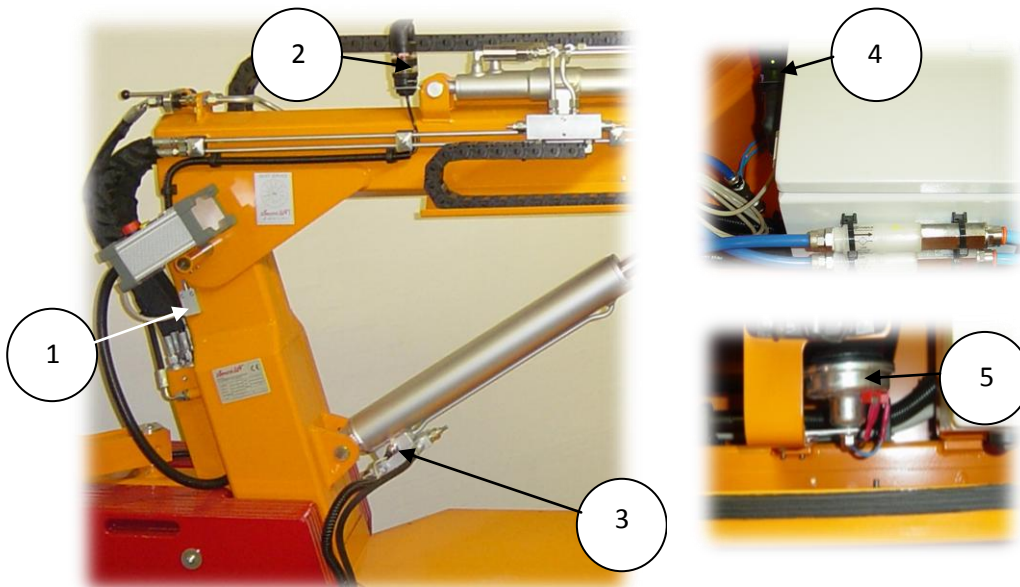

Pos	Part number	Description	Qty.
1	011202	Switch (end stop)	1
2	011190	Light tower	1
3	011144	Pressure transducer	1
4	011146	Load limiter	1
5	010262	Horn	1

10.0 - Main fuse and electrical cabinet

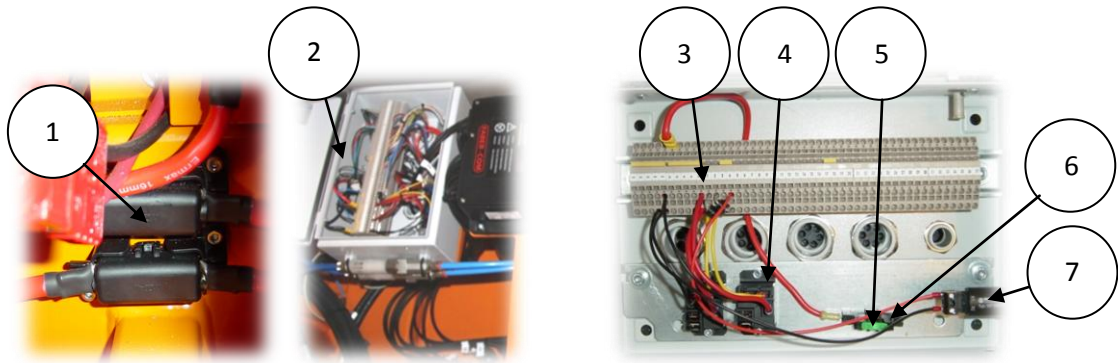

Pos	Part number	Description	Qty.
1	010252	Fuse socket	2
1a (inside 1)	010251	Fuse 100 Amp	2
2	010644	Electrical box	1
2a	001085	Electrical box, comp.	1
3	011175	Terminal block	50
4	010603	Relay (Vacuum pump)	2
5	010255	Fuse 30 Amp	1
6	010613	Fuse socket	1
7	010601	Acoustic alarm	1